

THE INFORMATION DISCLOSED HEREIN IS THE EXCLUSIVE PROPERTY OF HYDRA-SHIELD AND IS NOT TO BE REPRODUCED AND MUST BE TREATED AS CONFIDENTIAL MATERIAL.

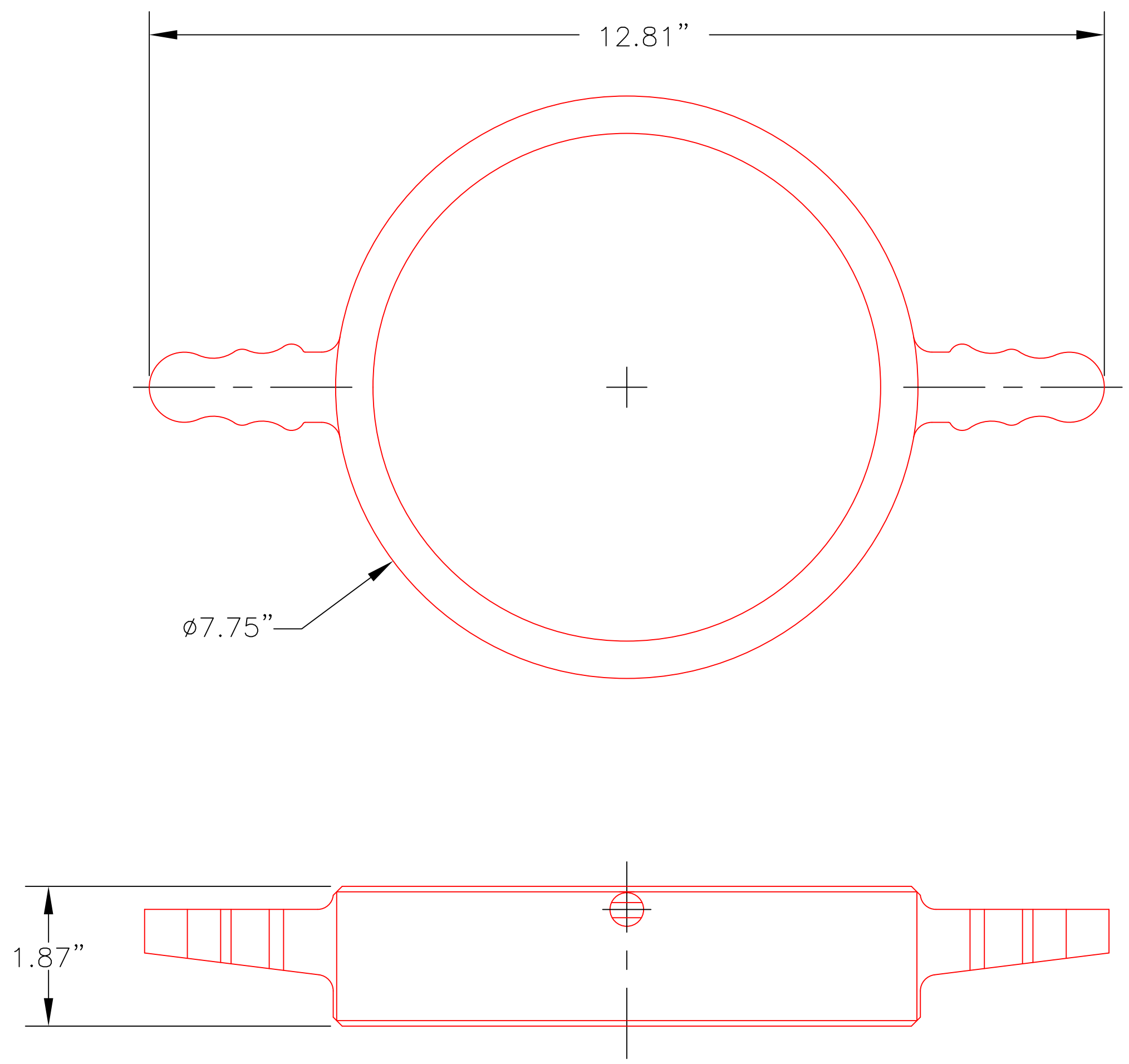

TOLERANCES—UNLESS OTHERWISE NOTED ANGULAR ±1° FRACTION ±1/16" .XX ±.030 .XXX ±.010 MACHINE FINISH 125 ALL DIA. <input checked="" type="checkbox"/> .015 B REMOVE ALL BURRS CORNERS .06x45° FILLETS R.06					
	0	LAST CHANGE DATE 4/29/19			JPM
	REV.	DESCRIPTION	DATE	CHK'D	DRWN



6.0-4NH SWIVEL

SIZE	SCALE	SHEET NO.	REV. NO.	REF. NO.
	NONE	6.0A		521901